



 Jardins du
Roi Soleil

Artisan d'art fournisseur du Château de Versailles





Artisan d'art fournisseur du Château de Versailles

Boutique en ligne / Online shop



www.jardinsduroisoleil.com



www.instagram.com/jardinsduroisoleil

Tél. : + 33 (0)1 43 44 44 31
jrs@jardinsduroisoleil.com



MOBILIER DE JARDIN

Si l'histoire de Jardins du Roi Soleil a commencé avec la caisse à oranger « Château de Versailles® », elle s'étend aujourd'hui à tout le domaine du mobilier et de l'ornement de jardin.

Les modèles classiques de caisses, de bancs et de vases issus des jardins de Versailles sont produits et commercialisés sous licence de marque exclusive de l'Etablissement Public du Château de Versailles, conférant à tous ces produits une garantie d'origine, d'authenticité et de qualité. La fabrication est entièrement française.

Des modèles contemporains, dessinés dans la lignée des modèles classiques, et également produits en France selon les critères de la plus haute tradition artisanale, viennent compléter cette gamme, ainsi que de nombreuses réalisations sur-mesure

GARDEN FURNITURE

The history of the Jardins du Roi Soleil (Sun King's Gardens) may have started with the "Château de Versailles®" tree box, but nowadays extends over the whole sphere of garden furniture and garden ornament.

Classic designs of tree boxes, benches and urns from the gardens of Versailles have been produced and marketed under licence with the exclusive brand name of the Etablissement Public du château de Versailles (château of Versailles Public Agency), giving all these products a guarantee of origin, authenticity and quality. The manufacture is entirely French.

This range is completed by contemporary models, designed in the tradition of a classic style and also produced in France following the highest craftsman standards, as well as various entirely custom-made projects.





JARDINS DU ROI SOLEIL & VERSAILLES

Jardins du Roi Soleil est un partenaire historique du Château de Versailles. La fameuse caisse à orangers "Château de Versailles®" a été redessinée, sur base d'une adaptation XIX^e des caisses en bois dessinées par Le Nôtre vers 1670. Les 1500 caisses à oranger utilisées aujourd'hui par les jardiniers de l'Orangerie sont des outils horticoles d'une grande ingéniosité. Une proche collaboration avec les jardiniers a permis d'apporter à ce modèle les améliorations techniques dont bénéficient aujourd'hui tous les acquéreurs de ce produit unique, souvent imité mais jamais égalé.

Jardins du Roi Soleil is a historical partner of the Chateau de Versailles. Its famous "Château de Versailles®" planter has been redesigned, based on a 19th-century adaptation of the tree boxes designed by Le Nôtre around 1670. The 1500 tree boxes used today by the gardeners in the Orangerie are extremely ingenious horticultural tools. Through close collaboration with the gardeners, technical improvements were made to this box, that benefit all those who acquire this unique model today – a model often imitated but never equalled.

LES CAISSES À ORANGER COULEURS ET MACARONS

Les caisses sont proposées dans une gamme de douze couleurs de base adaptées à la plupart des environnements pour faciliter les choix de nos clients, dont la couleur historique vert Versailles.

Cette gamme n'est cependant pas limitative : Jardins du Roi Soleil répond à toute demande de personnalisation, qu'il s'agisse d'utiliser une référence RAL, de contretyper une couleur originale, ou de réaliser des patines spécifiques sur la fonte et sur le bois. Il en est de même pour les macarons figurant l'année de fabrication et l'estampille de la société, que nous pouvons personnaliser à la demande.

ORANGE PLANTERS COLOURS AND "VANITY PLATES"

To assist our customers in their choice, the boxes are offered in a range of twelve basic colours – including the historical Versailles green – suitable for most environments.

These are however not the only possibilities – Jardins du Roi Soleil will respond to all requests for customisation, whether this involves using an RAL reference to match an original colour, or to produce a specific finish on cast iron and wood.

The same applies to the "vanity plates" bearing the year of manufacture and the stamp of the company, that we can personalise on request.

Blanc
White



Papyrus
Papyrus



Noir
Black



Soie
Silk



Amande
Almond



Versailles
Versailles



Provence
Provence



Pigeon
Pigeon



Olive
Olive



Ivoire
Ivory



Vauban
Vauban



Citrouille
Pumpkin



LES CAISSES À ORANGER TAILLES

Les caisses sont proposées dans une gamme de huit tailles mesurées aux dimensions des cubes de culture, de 50 cm (500) à 1,50 m (1500), et adaptées à la culture de nombreuses variétés de plantes.

ORANGE PLANTERS SIZES

Tree boxes are offered in a range of eight sizes, giving the measurements of the volume of the cultivation box, from 50cm (500) to 1.5m (1500), and they are suitable for growing numerous varieties of plants.

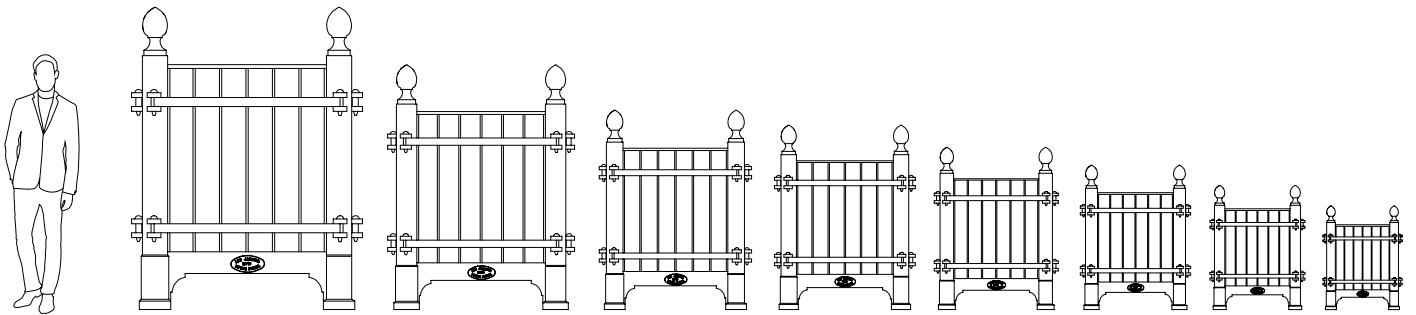

largeur / mm	1500	1200	1000	900	800	700	600	500
width / inch	59,05	47,24	39,37	35,43	31,49	27,55	23,62	19,68
poids / vide / kg	1250	720	365	285	240	170	120	75
weight / empty / lbs	2750	1588	803	627	528	374	264	165



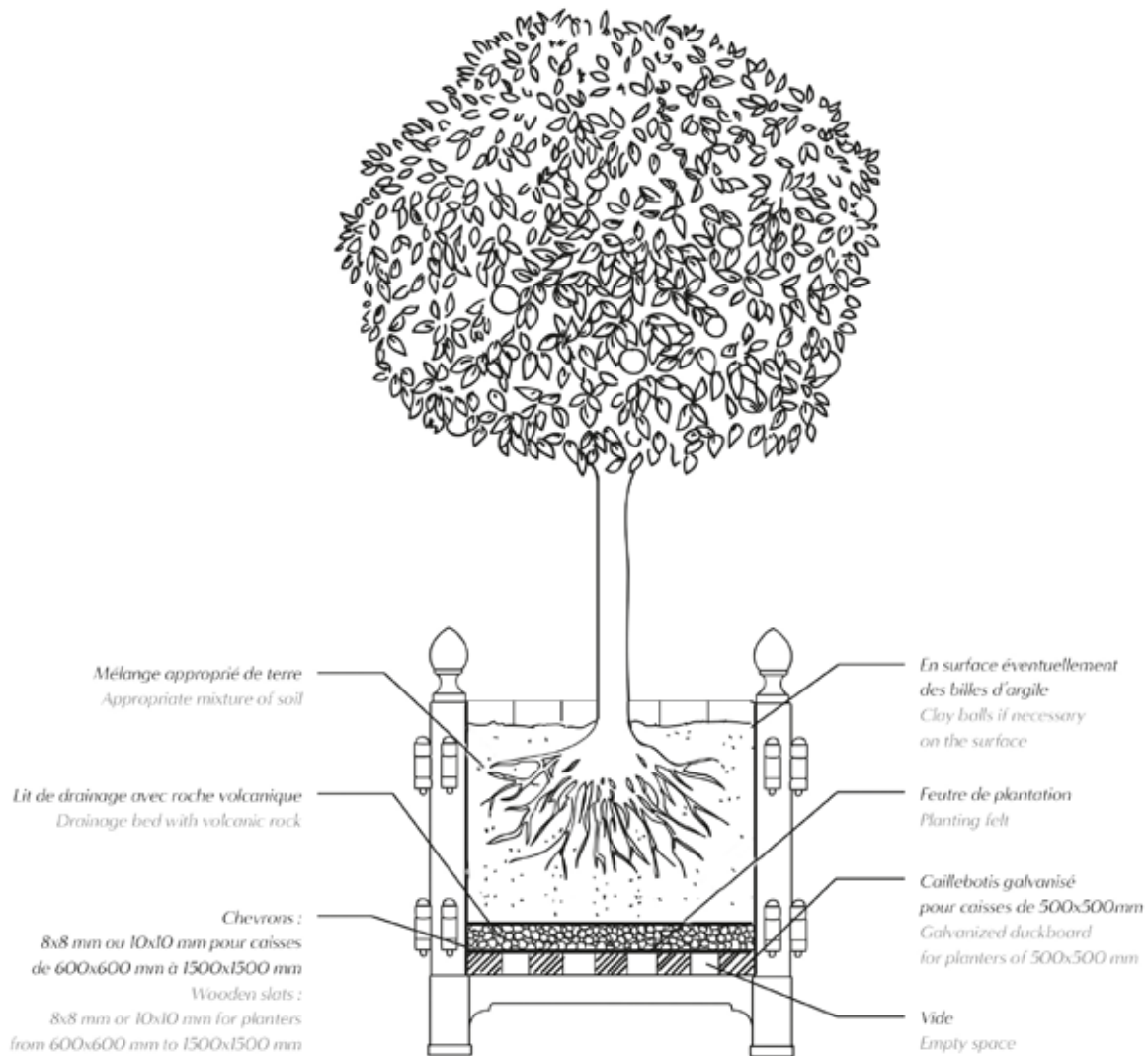

Sans fond ni bac interne, la reprise des végétaux est favorisée par un meilleur drainage et une bonne aération du mélange terreux. Les quatre panneaux latéraux sont amovibles, donnant un accès direct à la motte et permettant ainsi les soins nécessaires aux racines.

Bottomless and without internal tray, growth of plants is enhanced by better drainage and proper ventilation of the soil. The four side-panels can be opened, allowing direct access to the soil and the necessary care of the roots.





FABRICATION

CHÊNE MASSIF

D'origine française, région Centre et Bourgogne

FONTE

Coulée dans une fonderie française pour obtenir une structure inaltérable pouvant durer jusqu'à 150 ans

TRAITEMENT ANTIROUILLE ET PEINTURE

Protection anticorrosion par trempage, une couche apprêt et deux couches de peinture polyuréthane respirante

SOLID OAK

French origin, Centre and Bourgogne region

CAST-IRON

Cast in a French foundry, the structure can last for over a century

RUST PROOFING AND PAINT

Dip coating anticorrosive protection, one primer coating and two porous polyurethane painting layers





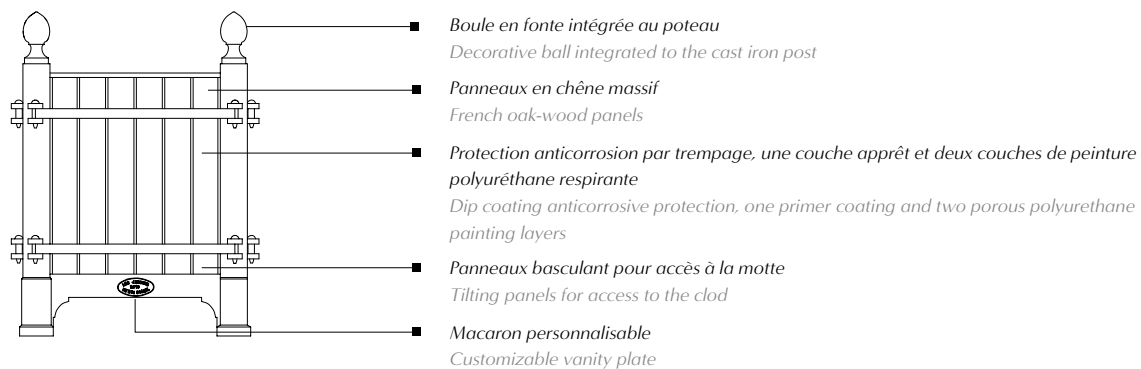



© Pascal Le Mée



© Pascal Le Mée





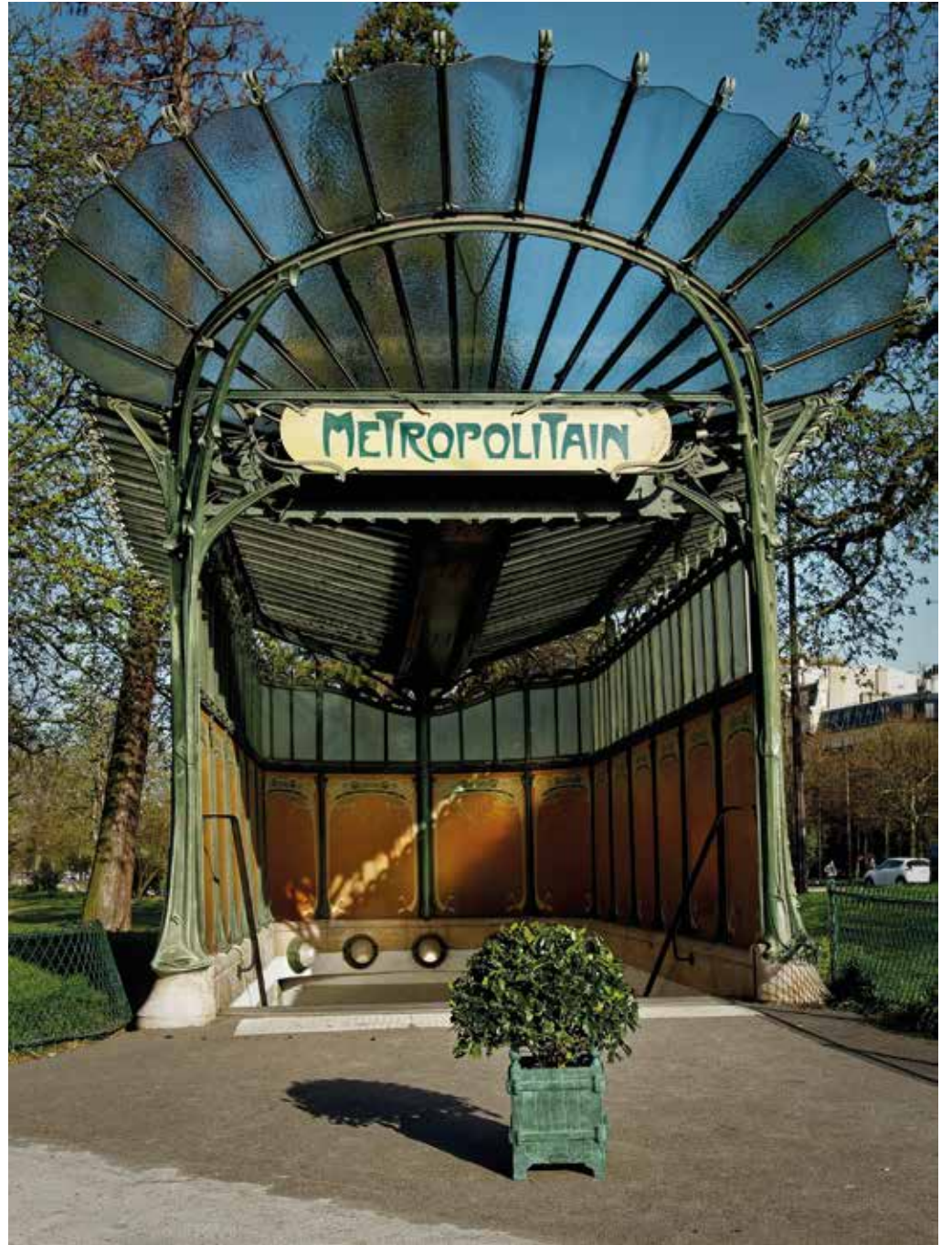





Le Bristol - Paris





Jardin des Tuileries





*Jardin privé
Private garden*











Château de la Ballue



SUR MESURE...

Réalisation de projets sur mesure, dans les mêmes matériaux et les mêmes inspirations. Depuis des jardinières rectangulaires ou des modèles octogonaux pour des plantes monumentales, jusqu'à des bacs aquatiques, ou encore des modèles de caisses sans boules d'ornement, en passant par des jardinières sonorisées... ou plus simplement des arrosages par buse de fond ou des bacs internes galvanisés

CUSTOM MADE...

Recent projects - in the same materials and inspiration - include rectangular custom planters or octagonal pieces for monumental tree specimen, aquatic planters, models without ornament balls, and even sound woofer fitted rectangular planters... and also simpler equipments like bottom watering noozles or internal galvanized inside containers

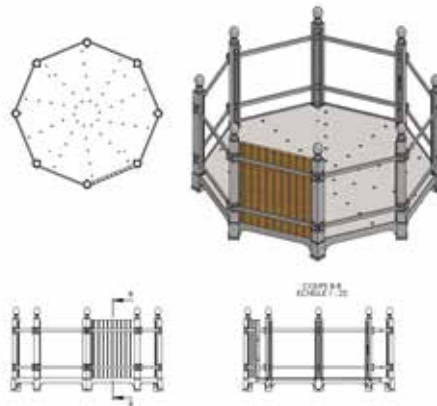



*Un soin extrême est
apporté de la sélection des
matériaux - fonte et bois
de chêne des meilleures
provenances françaises -
jusqu'à l'emballage et la
livraison.*

*An extreme attention is
brought from the selection
of the materials - cast
iron and oak from the
best French origin - to the
packaging and delivery.*



LES JARDINIÈRES



Les jardinières peuvent être déclinées en plusieurs tailles, et équipées de dispositifs sur mesure, comme pour un projet récent où elles ont été agrémentées de portillons pour clore un jardin d'agrément

Jardinière sur le modèle de la caisse à oranger « Château de Versailles® »

Taille standard :

-Largeur et hauteur 500 mm, 600 mm et 700 mm

-Longueur 1000 mm ou 1200 mm

The rectangular planters can come in various dimensions, and be fitted with custom equipments (a recent project includes a gate fitted in the planters' sides to separate a fancy garden)

Rectangular planter after the "Château de Versailles®" orange tree box

Standard Size (inch):

-Width & height 19,6 inch , 23,6 inch and 27,6 inch

-Length 39,4 inch or 47,4 inch

RECTANGULAR PLANTERS







LES BANCS DE VERSAILLES

« Le début du XVII^e siècle voit en France les grands jardins royaux et aristocratiques développer, en complément de bancs fixes de pierre ou de marbre, l'usage d'un mobilier de bois permettant aux promeneurs de profiter du jardin avec plus de liberté mais aussi de confort. Tout d'abord constitué de sièges d'intérieur sortis à la belle saison, celui-ci va vite prendre la forme, pour des questions de résistance, de stabilité et de durabilité, d'ouvrages

de menuiserie spécifiquement conçus et réalisés pour cet usage. Jardins du Roi Soleil, spécialiste reconnu de mobilier de jardin de prestige, entreprend aujourd'hui, l'édition des modèles les plus caractéristiques ».

P-A. Lablaude, A. C. M. H.
Architecte en Chef des Monuments Historiques

VERSAILLES BENCHES

“The start of the 17th century saw the development of the great royal and aristocratic gardens in France. Along with fixed benches in stone or marble, the use of wooden furniture allowed walkers to enjoy the garden with more freedom as well as more comfort. First of all consisting of indoor benches taken outside during the summer, this soon took the form of wooden items that were specially designed and made for this purpose,

to be more resistant, stable and durable. Jardins du Roi Soleil, a renowned specialist in prestige garden furniture, today is producing versions of the most characteristic models.”

P-A. Lablaude, A. C. M. H.
Chief Architect for French Historical Monuments

LES BANCS SUR-MESURE DE JARDINS DU ROI SOLEIL

Dessinés par Pierre-André Lablaude d'après les gravures originales datant du XVII^e siècle, les bancs de Versailles sont réédités sous contrat de licence exclusive du château de Versailles.

Ils sont réalisés artisanalement en chêne massif d'origine française et proposés en trois tailles et douze couleurs de base : deux, trois ou quatre places mesurant respectivement : 4 pieds (env. 140 cm), 1 toise (env. 200 cm), et 1 toise 2 pieds (260 cm). Tous les modèles peuvent être déclinés et adaptés sur-mesure : taille, galbe, coloris, patines, etc.

JARDINS DU ROI SOLEIL MADE-TO-MEASURE BENCHES

Designed by Pierre-André Lablaude following original engravings from the 17th century, Versailles benches are reproduced under an exclusive licence from the château de Versailles.

They are craftsman made in solid French oak, and offered in three sizes and twelve standard colours. They have two, three or four places, and measure respectively: 4 feet (approx. 55.1 in), one "toise" (approx. 78.7 in), and one "toise" 2 feet (approx. 102.4 in). All the models can be adapted and customised: size, curve, colour, finish, etc.



- *Découpes, motifs et sculptures sont effectuées à la main et dans la masse. Handcrafted indents, patterns and sculptures from the block.*
- *Les assemblages sont réalisés traditionnellement par tenons, mortaises et chevilles à la tire. Traditional mortise, tenon and dowel assembly.*
- *L'ensemble des éléments reçoit une couche d'impression avant assemblage et finitions. All fittings are coated with primer before assembly and finish.*





DUC DE PENTHIÈVRE



COUPE

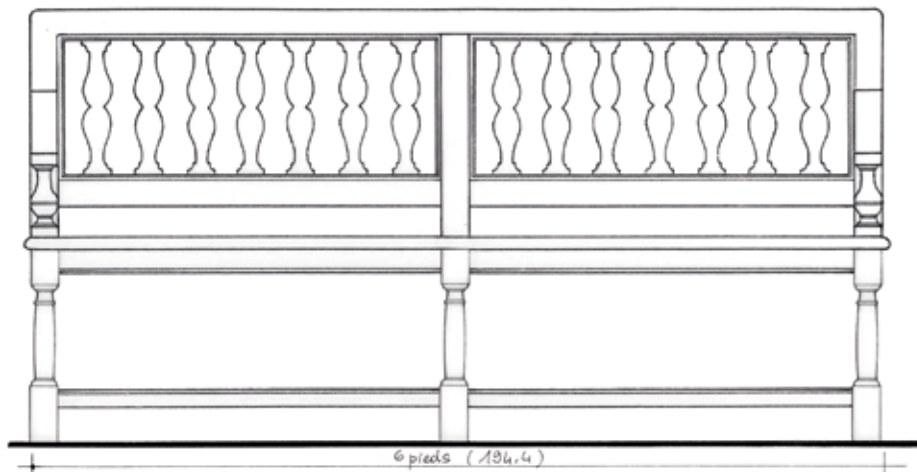

VUE DE FACE
modèle à 6 pieds.

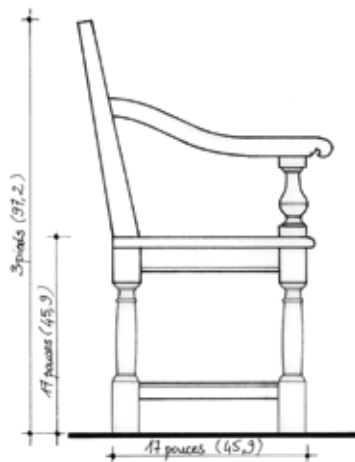

VUE DE PROFIL

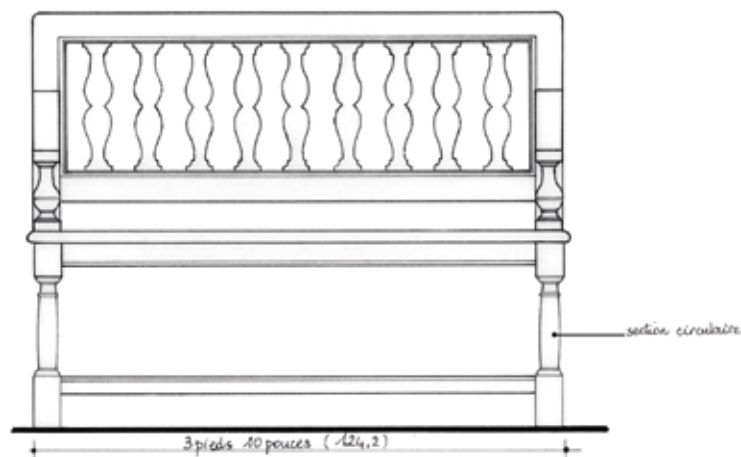

VUE DE FACE
modèle à 4 pieds



Duc de Penthièvre

Banc à balustres chantournés.

Pieds tournés, accoudoirs chantournés.

Duc de Penthièvre

Fretted baluster bench.

Turned feet, fretted armrests.





DUC DE PENTHIÈVRE COURBE

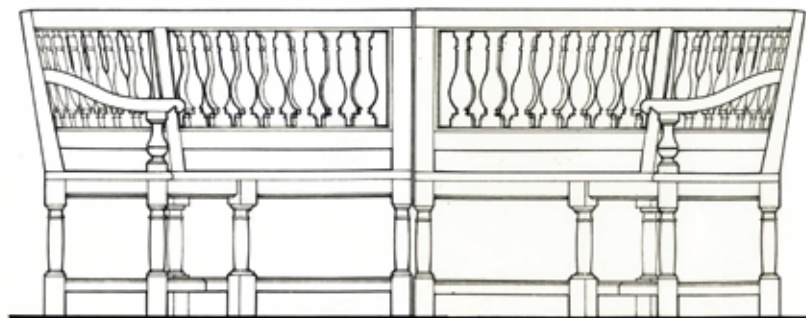
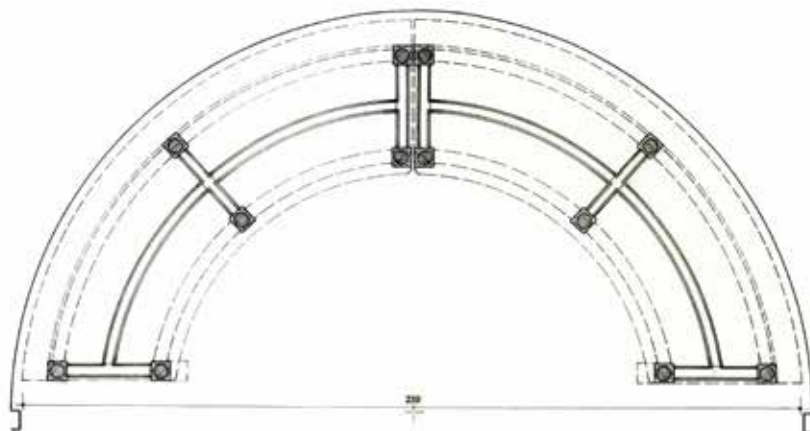

12 places (60,5)
ÉLEVATION VUE DE FACE
(2 bancs en quart de cercle à 6 pieds chacun)

Duc de Penthièvre
Banc à balustres chantournés.
Pieds tournés, accoudoirs chantournés.

Duc de Penthièvre
Fretted baluster bench.
Turned feet, fretted armrests.





TRIANON

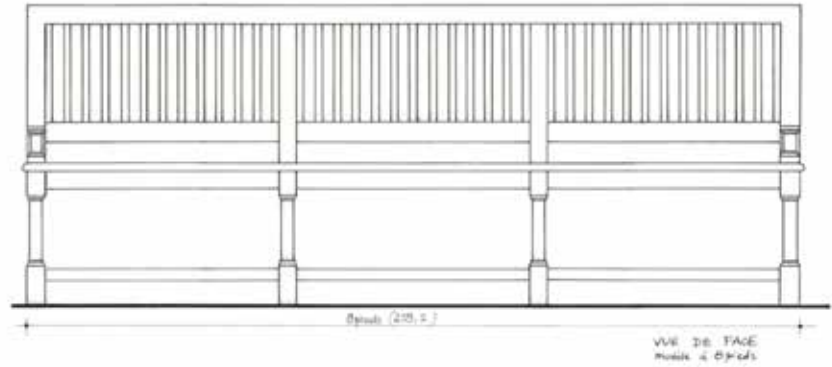

Trianon
Banc à balustres droits moulurés.
Pieds droits, accoudoirs chantournés.

Trianon
Straight mouldered baluster bench.
Straight feet, fretted armrests.



VASES

VASE EN PIERRE

On retrouve ce modèle simple et classique en différents endroits du parc de Versailles, particulièrement sur le parterre Nord dans la descente vers les Marmousets. Il est réalisé en pierre calcaire de Savonnières.

VASES EN BRONZE

Présents sur le parterre du Midi, plusieurs modèles de vases en bronze dessinés par Claude Ballin en 1665 ornent les abords de la terrasse. Jardins du Roi Soleil en édite deux modèles.

CAISSE EN BRONZE 25CM

Ce petit modèle en bronze massif est patiné en vert de gris ou brun.

STONE VASE

This clean and classic vase design can be found in various places throughout the Park of Versailles, particularly in the Parterre du Nord heading towards the Allée des Marmousets. It is carved from Savonnières limestone.

BRONZE VASES

Standing in the Parterre du Midi, several of the bronze vases designed by Claude Ballin in 1665 grace the perimeter of the terrace. Jardins du Roi Soleil edits two of these vase designs.

BRONZE PLANTERS 25CM

This small planter model is cast in massive bronze, with a brown or vert-de-gris patina.





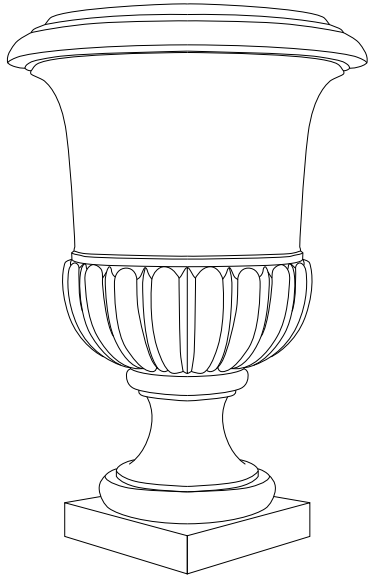

Vase en pierre

Réalisé en pierre calcaire de Savonnières

- Hauteur totale : 83 cm
- Diamètre haut : 59 cm
- Socle : 30 cm

Stone vase

Carved from Savonnières limestone

- Total height : 32.6 in
- Top diameter : 23.2 in
- Base : 4.7 in



Vases en bronze

*Jardins du Roi Soleil a choisi
d'en éditer deux modèles.*

- Hauteur totale : 90 cm - 72 cm

- Diamètre : 60 cm - 58 cm

- Socle bas : 35 cm - 38 cm

Bronze vases

*Jardins du Roi Soleil has edited two of these vase
designs.*

- Total height : 35,4 in - 28,3 in

- Diameter : 23,2 in - 22,8 in

- Low base : 13,7 in - 14,9 in



OBJETS ET CADEAUX

PRESSE PAPIER EN BRONZE

Le macaron emblématique des caisses à oranger des Jardins du Roi Soleil s'invite dans votre intérieur. Chaque pièce est méticuleusement coulée par des artisans d'art français. Il est proposé en trois designs différents.

PRESSE PAPIER EN BRONZE PERSONNALISÉ

Ce presse papier peut être personnalisé à votre convenance avec votre logo, un nom, un emblème.

CAISSE MINIATURE EN BRONZE

Déclinaison de l'iconique caisse à oranger du Château de Versailles, c'est l'accessoire idéal pour sublimer votre espace intérieur. Ce petit modèle en bronze massif est patiné en vert de gris.

BRONZE PAPERWEIGHT

The iconic medal from the orange tree planter of Jardins du Roi Soleil is coming to your home. Each piece is meticulously cast by French artisans. It is available in three different designs.

PERSONALIZED BRONZE PAPERWEIGHT

This paperweight can be personalized to your liking with your logo, a name or an emblem.

MINIATURE BRONZE PLANTER

A variation of the iconic orange tree planter from the Château de Versailles, it is the ideal accessory to enhance your interior space. This small model in solid bronze is patinated in verdigris.





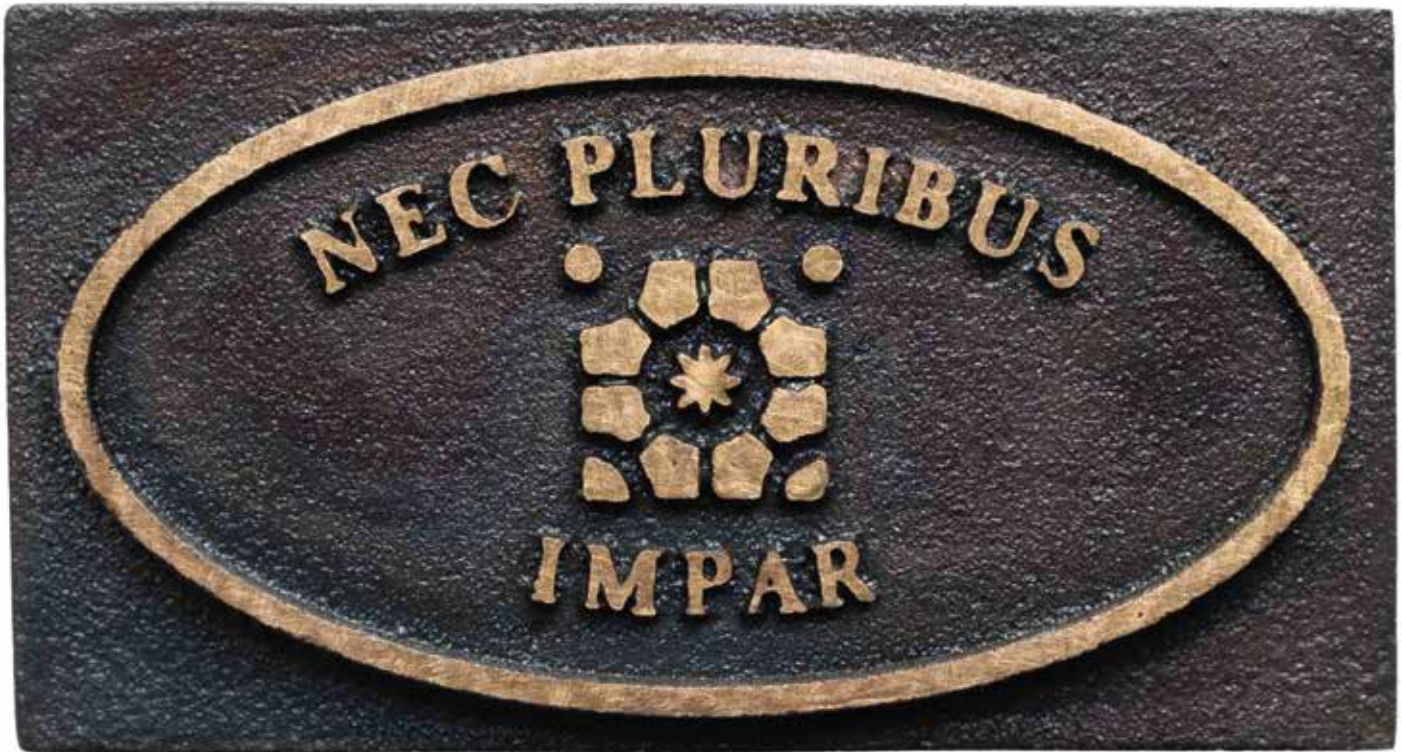

Presse papier en bronze

- Dimensions : 11,7 cm x 6,3 cm

- Poids : 528 gr

A l'unité, par lot de 5 ou lot de 20 pièces

Personnalisation possible

Bronze paperweight

- Dimensions : 4.60 in x 2.48 in

- Weight : 1.164 lbs

Unit, set of 5 or set of 20 pieces

Customization possible



Caisse en bronze miniature

Pour vos tables et bureaux

- Hauteur totale : 18 cm
- Largeur : 12,4 cm
- Poids : 4,6 kg

Miniature bronze planter

For your tables and desks

- Total height : 7,08 in
- Width : 4,88 in
- Weight : 10,14 lbs



Caisse en bronze

Pour vos balcons et terrasses

- Hauteur totale : 38 cm
- Largeur : 25 cm
- Poids : 38 kg

Bronze planter

For your balconies and terraces

- Total height : 14,96 in
- Width : 9,84 in
- Weight : 83,77 lbs







Structure 1862 patinée par le temps
1862 structure weathered by time

LIGNE JARDIN

TABLE D'APPOINT

Notre table d'appoint en fonte et verre reprend la structure de la caisse à oranger emblématique de l'orangerie du Château de Versailles, une fusion parfaite de robustesse et de sophistication. Elle est proposée dans une patine ancienne et unique travaillée à la main par nos artisans d'art français, peintres patineurs, reproduisant la patine authentique d'une structure datant de 1860. La table est disponible également dans la peinture Vert « Versailles » de notre gamme.

Table d'appoint

Structure en fonte de la caisse à oranger 500 mm

- Etagère en verre sécurité 8 mm
- Hauteur totale : 74 cm
- Largeur : 50 cm
- Poids : 66 kg



SIDE TABLE

Our cast iron and glass side table takes its structure from the emblematic orange tree planter in the orangery at the Château de Versailles, a perfect fusion of robustness and sophistication. It is available in an old and unique antique patina, hand-worked by our French craftsmen, reproducing the authentic patina of a structure dating from 1860. The table is also available in the "Versailles" green from our range.

Side table

Cast iron structure of the orange tree planter 500 mm

- Shelf in 8mm safety glass*
- Total height : 29.19 in
- Width : 19.68 in
- Weight : 145.5 lbs



*Patine travaillée par nos artisans
Patina crafted by our artisans*







Artisan d'art fournisseur du Château de Versailles

Boutique en ligne / Online shop



www.jardinsduroisoleil.com



www.instagram.com/jardinsduroisoleil

Tél. : + 33 (0)1 43 44 44 31
jrs@jardinsduroisoleil.com



 Jardins du
Roi Soleil

Artisan d'art fournisseur du Château de Versailles

